

GLASS
SYSTEMS



PALMIYE
Four Seasons Outdoor Living Areas

W I D E N Y O U R V I E W



INDEX

FOLDING GLASS SYSTEMS

08
Standard System

12
Hanging System

16
Butterfly System

20
Double Glass Folding System

SLIDING GLASS SYSTEMS

26
3 Railed Sliding System

30
5 Railed Sliding System

34
Double Glass Sliding System

20
Double Glass Folding System

FIXED & ADJUSTABLE SYSTEMS

44
Section System

46
Adjustable Parapet System

52
Parapet System

38
Lift and Slide System

DOOR SYSTEMS

62
Glass Door

64
Photocell Door

66
Aluminium Door

ACCESSORIES

70
Handles

72
Locks



D E E P E R R E F L E C T I O N S



FOLDING GLASS SYSTEMS

STANDARD SYSTEM

GLASS SYSTEMS ▶ FOLDING GLASS SYSTEMS

This is a successful architectural solution that integrates indoor comfort with an outdoor living space.

This stunning design concept has been intricately developed in order to fit with any type of architecture, classic or modern. A delightful design line running throughout the product enables any colour combination so that it can be personalized to individual taste. Due to the innovative suspension system each glass panel slides smoothly into place.



CONFIGURATIONS

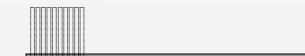
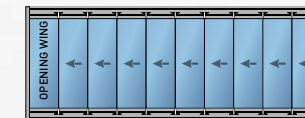

Single opening wing

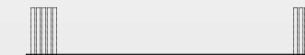
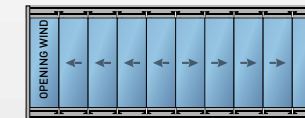

Double opening wing

GLASS OPTIONS

- » 8mm Tempered
- » 8mm Tempered (Coloured)

GLASS COLOR OPTIONS

- » Transparent (Standard)
- » Blue
- » Green
- » Smoked

DIMENSIONS

Max Height	240 cm
Max Width	600 cm
Max Wing Width	67 cm
Min Wing Width	50 cm

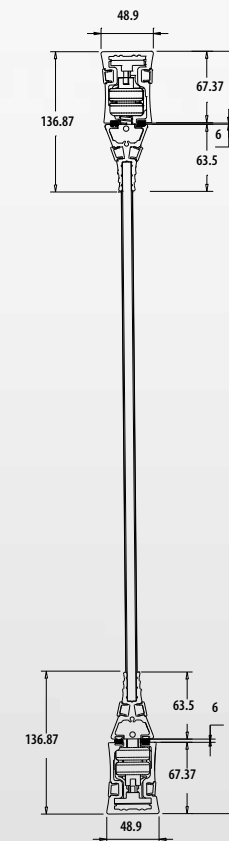



HANGING SYSTEM

GLASS SYSTEMS ▶ FOLDING GLASS SYSTEMS

With its special frameless design the customer is able to enjoy the panoramic views around them, from within the enclosed area.

With a specially designed joint system, that screws the glass directly to the profile providing extra strength and stability, the glass panels are moved safely only along the top rail. This wheel system has an intelligent parking technology where the pane of glass is guided into the right track by itself.

Wheels at the top of each panel are adjustable to ensure easy manoeuvring.



CONFIGURATIONS

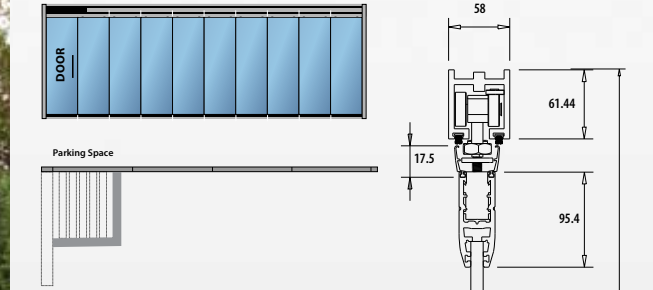

GLASS OPTIONS

- » 10mm Tempered
- » 10mm Tempered (Coloured)

GLASS COLOR OPTIONS

- » Transparent (Standard)
- » Blue
- » Green
- » Smoked

DIMENSIONS

Max Height	350 cm
Max Width	600 cm
Max Wing Width	95 cm
Min Wing Width	75 cm

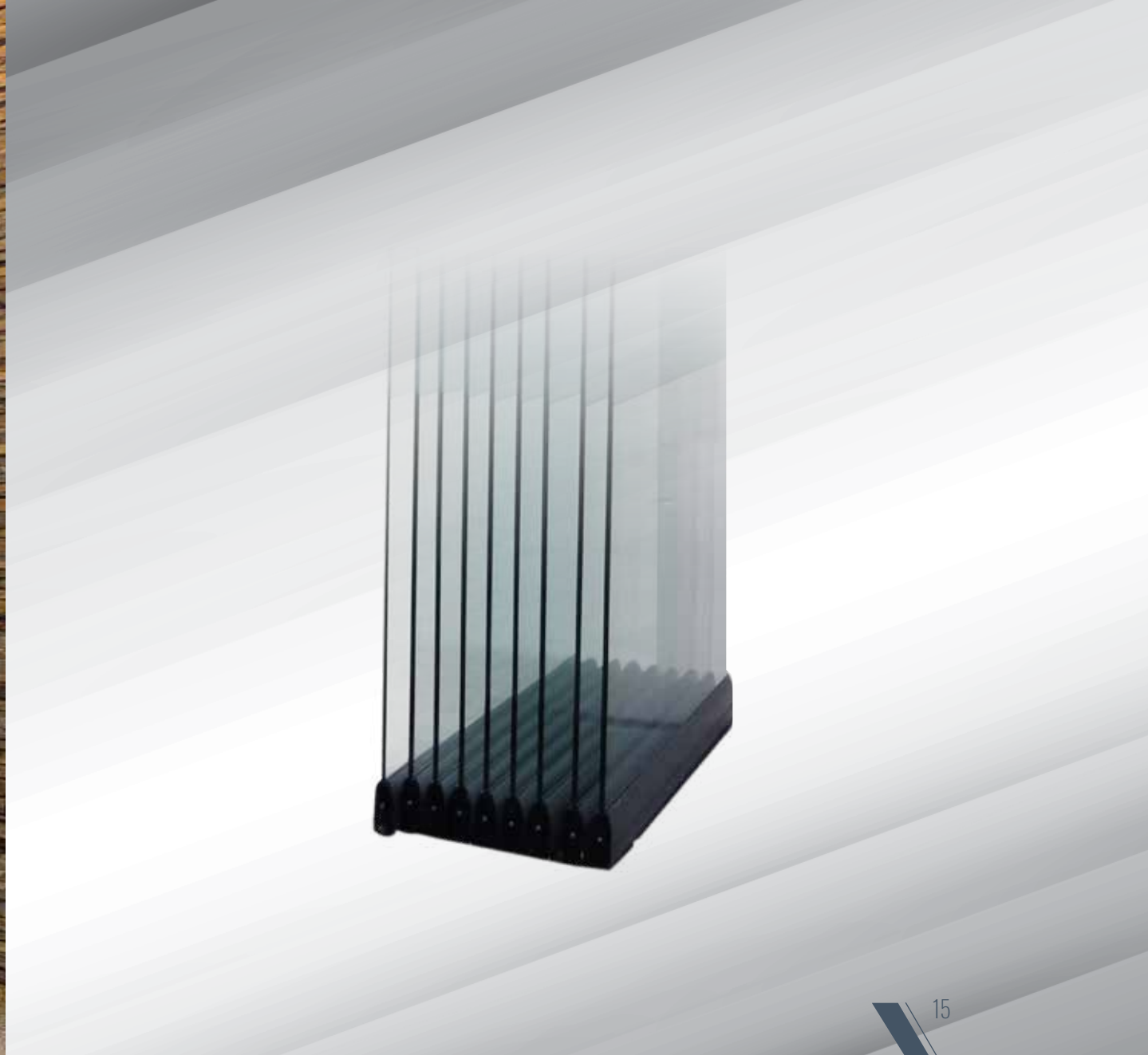

BUTTERFLY SYSTEM

GLASS SYSTEMS ▶ FOLDING GLASS SYSTEMS

The butterfly system is carried along the top rail from a centrally placed wheel.

Along the bottom of the window pane there is a special rubber seal which prevents rain and air. The wheel system at the top of each wing is adjustable to ensure easy manoeuvring of the panels. Completely transparent views enable a life intertwined with nature.



CONFIGURATIONS

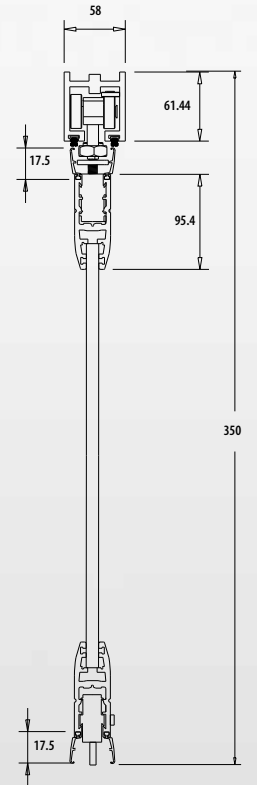

GLASS OPTIONS

- » 10mm Tempered
- » 10mm Tempered (Coloured)

GLASS COLOR OPTIONS

- » Transparent (Standard)
- » Blue
- » Green
- » Smoked

DIMENSIONS

Max Height	350 cm
Max Width	600 cm
Max Wing Width	95 cm
Min Wing Width	75 cm



DOUBLE GLASS FOLDING SYSTEM

GLASS SYSTEMS ▶ FOLDING GLASS SYSTEMS

This protective and classy concept has been developed in order to provide maximum comfort to any living space.

Each panel is enclosed with an aluminium frame and in turn connected to each other with strong hinges.

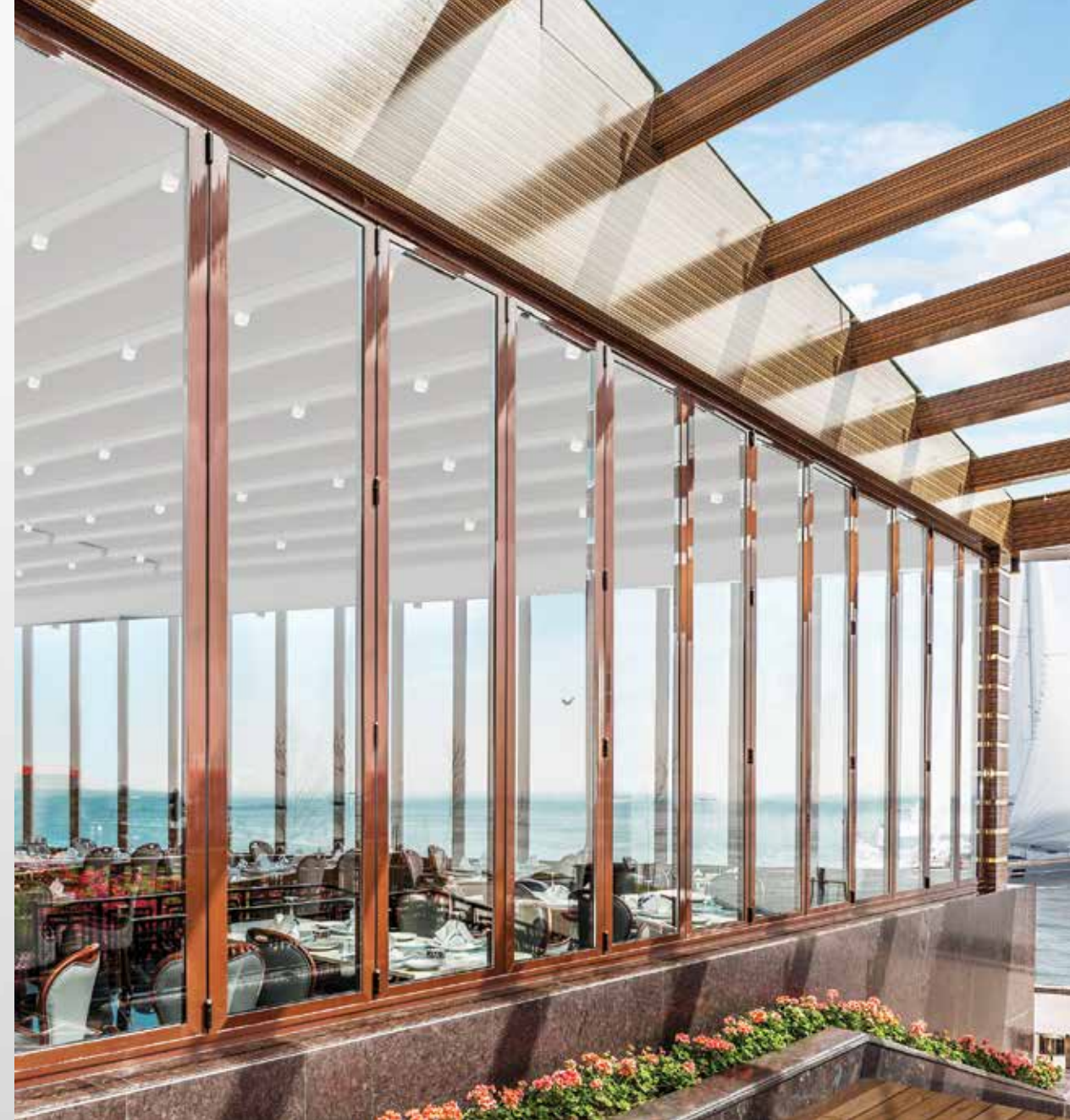

STANDARD CONFIGURATIONS

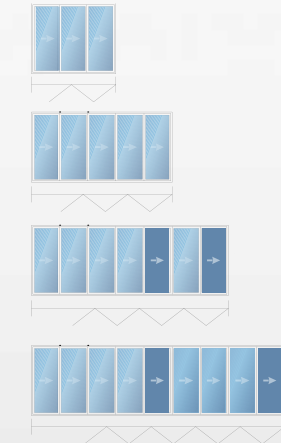

GLASS OPTIONS

- » Glass 4+16+4 mm Insulated tempered

GLASS COLOR OPTIONS

- » Transparent (Standard)
- » Blue
- » Green
- » Smoked

DIMENSIONS

Max Height	260 cm
Max Width	600 cm
Max Wing Width	100 cm
Min Wing Width	60 cm

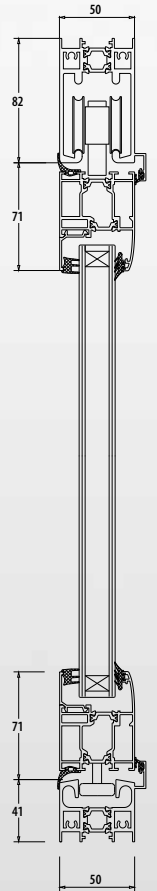





SLIDING GLASS SYSTEMS

3 RAILED SLIDING SYSTEM

GLASS SYSTEMS ▶ SLIDING GLASS SYSTEMS

This stylish glass system is completely waterproof and with our specially designed drainage detail even the smallest of raindrops will be caught and guided out again.

A perfect product for any building, its adjustable wheels ensure smooth manoeuvring of each panel to both left and right.



CONFIGURATIONS

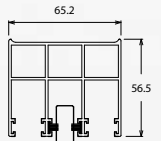
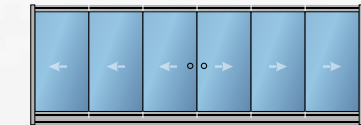

GLASS OPTIONS

- » 10mm Tempered
- » 10mm Tempered (Coloured)

GLASS COLOR OPTIONS

- » Transparent (Standard)
- » Blue
- » Green
- » Smoked

DIMENSIONS

Max Height	260 cm
Max Width	600 cm
Max Wing Width	100 cm
Min Wing Width	75 cm

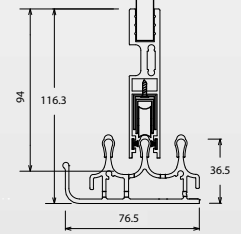



5 RAILED SLIDING SYSTEM

GLASS SYSTEMS ▶ SLIDING GLASS SYSTEMS

The 5 railed glass system is the perfect solution for large living areas that you want to maximize the use of.

The adjustable wheels ensure smooth manoeuvring and each panel is connected to the other enabling easy opening and closing.



CONFIGURATIONS

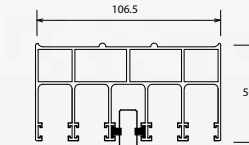
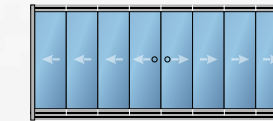

GLASS OPTIONS

- » 10mm Tempered
- » 10mm Tempered (Coloured)

GLASS COLOR OPTIONS

- » Transparent (Standard)
- » Blue
- » Green
- » Smoked

DIMENSIONS

Max Height	260 cm
Max Width	600 cm
Max Wing Width	100 cm
Min Wing Width	75 cm

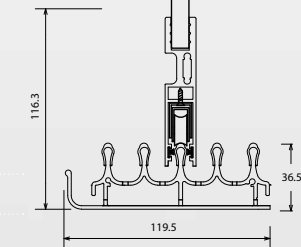



DOUBLE GLASS SLIDING SYSTEM

GLASS SYSTEMS ▶ SLIDING GLASS SYSTEMS

Buildings where insulation solutions have been prioritized, offers great comfort to its users.

With this solution you maximise the use of the natural heat that daylight provides.



CONFIGURATIONS

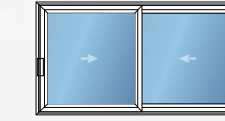

2 SLIDING WINGS

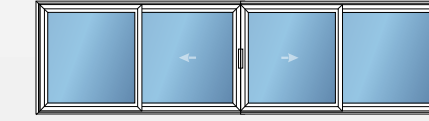

2 SLIDING WINGS 2 FIXED WINGS

GLASS OPTIONS

- » 4+12+4 Tempered Insulated
- » 4+12+4 Tempered Insulated (Coloured)

GLASS COLOR OPTIONS

- » Transparent (Standard)
- » Blue
- » Green
- » Smoked

DIMENSIONS

Max Height	250 cm
Max Width	600 cm
Max Wing Width	150 cm
Min Wing Width	90 cm

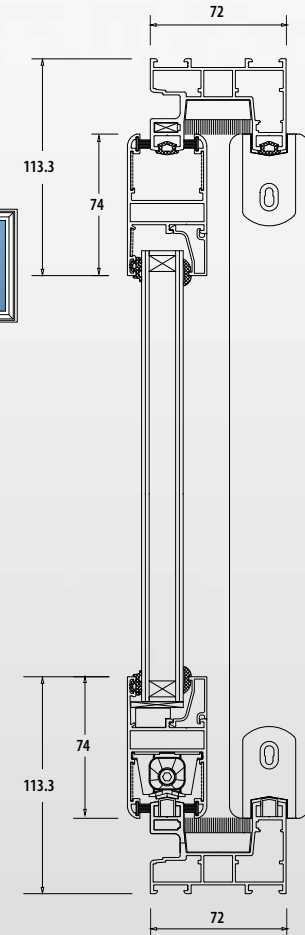



LIFT & SLIDE SYSTEM

GLASS SYSTEMS ▶ SLIDING GLASS SYSTEMS

When closed this system offers perfect water, wind and heat insulation and in addition to this the huge panels enable an unbroken panoramic view.



CONFIGURATIONS

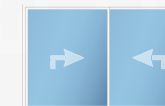

2 SLIDING WINGS

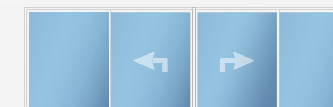

2 SLIDING WINGS 2 FIXED WINGS

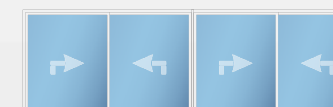

4 SLIDING WINGS

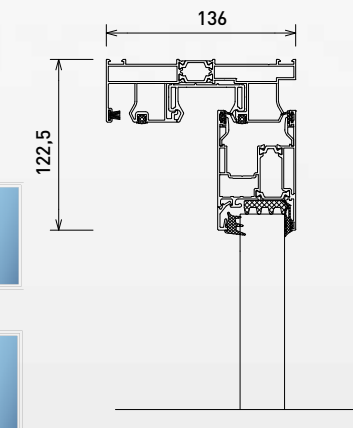

GLASS OPTIONS

- » Glass 6+14+4 mm
Tempered Insulated

GLASS COLOR OPTIONS

- » Transparent (Standard)
- » Blue
- » Green
- » Smoked

DIMENSIONS

Max Height	300 cm
Max Width	600 cm
Max Wing Width	200 cm
Min Wing Width	100 cm

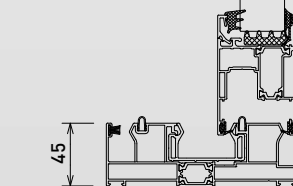





FIXED & ADJUSTABLE
SYSTEMS

SECTION & FIXED SYSTEM

GLASS SYSTEMS ▶ FIXED & ADJUSTABLE SYSTEMS

Dividing spaces with this section system creates a lighter and brighter atmosphere.

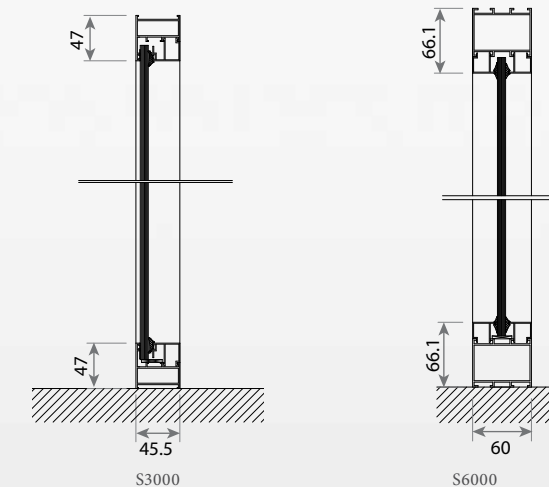

DIMENSIONS

Max Height	300 cm
Max Width	600 cm
Glass	4+4mm Laminated
Glass Color	Transparent

APPLICATIONS

	4+4 Laminated	5+5 Laminated	6+6 Laminated	Insulated Tempered (4+9+4)
S3000	✓	✓	✓	✓
S6000	✓	✓	✓	✓

OPTIONALS

OPTIONAL 01	Tempered Glass (for Laminated & Insulated)
OPTIONAL 02	Wood Effect Colors
OPTIONAL 03	Special Glass Colors Laminated (Glass Colors: Blue, Green, Smoked)
OPTIONAL 04	Special Glass Colors Insulated (Glass Colors: Blue, Green, Smoked)

ADJUSTABLE PARAPET SYSTEM

GLASS SYSTEMS ► FIXED & ADJUSTABLE SYSTEMS

Operating vertically this parapet system can function interiorly as a room divider, and exteriorly as a balcony and wind breaker.



CONFIGURATIONS

3 PANELS

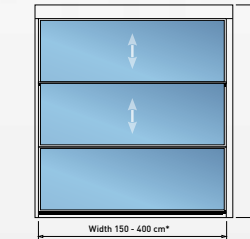

2 PANELS

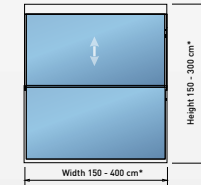

*Please refer to dimension table

GLASS OPTIONS

	3 Panels	2 Panels
Motorized Single Glass	8 mm Tempered	8 mm Tempered
Motorized Double Glass	5+12+5 Tempered	5+12+5 Tempered

GLASS COLOR OPTIONS

- » Transparent (Standard)
- » Blue
- » Green
- » Smoked

Glass Color : Transparent (Standard)

DIMENSIONS

		2 Panels Motorized				
Width		150-400cm	150-375cm	150-350cm	150-325cm	150-300cm
Height (max.)		200cm	225cm	250cm	275cm	300cm

*Maximum Height varies according to width correlation.

		3 Panels Motorized				
Width		150-400cm	150-375cm	150-350cm	150-325cm	150-300cm
Height (max.)		300cm	325cm	350cm	375cm	400cm

*Maximum Height varies according to width correlation.

Type 1 Motorized (Double Glass)

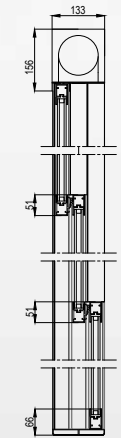

Type 1 Motorized (Single Glass)

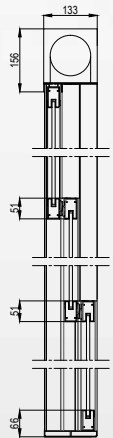

Type 2 Motorized (Double Glass)

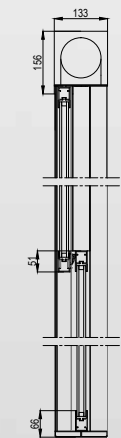

Type 2 Motorized (Single Glass)

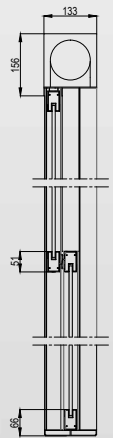





CONTROL & AUTOMATION



CONNEXOON

Designed to easily control your product wherever you are in the world, despite the weather changes you can remotely activate your products accordingly.

Compatible with iOS and Android smartphone systems. You can assign multiple functions through created scenarios, you can give a one-touch command.



- A** **Telis 1 - Pure** Elegant design that allows you to easily control your product.
* The standard control unity.
- B** **Telis 1 - Lounge** Elegant design with black color.
- C** **Telis 1 - Patio** IP 66 water-proof feature for outdoor use.
- D** 16-channel ergonomic design that allows you to control all functions at the same time from one control.



MULTI CHANNEL OPTIONS
Telis 1 is remote control with 1 channel, while the Telis 4 has got 5 channels. Telis 4 option is available for Pure, Lounge, Patio, RTS Lounge Roller and RTS Pure Roller.

PARAPET SYSTEM

GLASS SYSTEMS ▶ FIXED & ADJUSTABLE SYSTEMS

With its strong frameless panels the Parapet system provides uninterrupted views as well as a welcome wind shield too.



Model 1

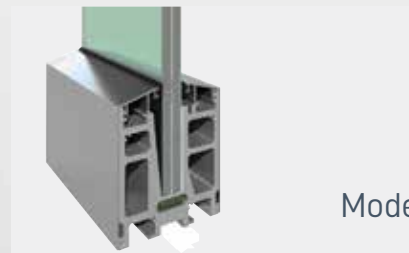

Model 2

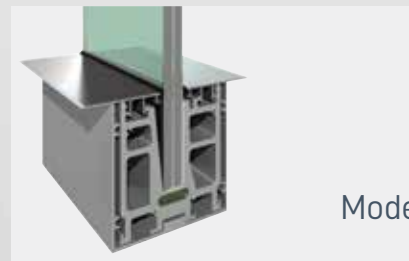

Model 3

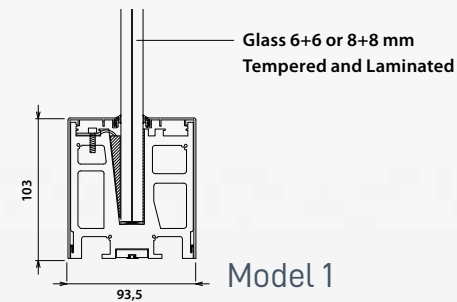

Model 1

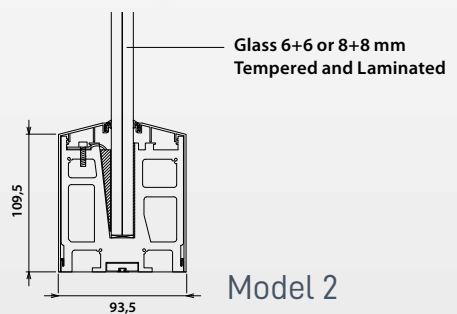

Model 2

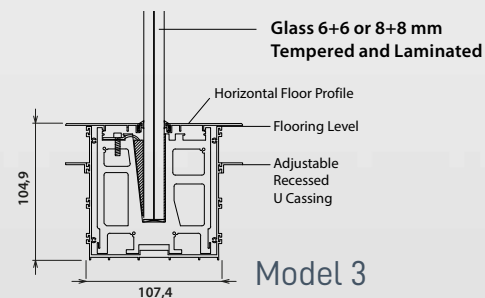

Model 3

GLASS COLOR OPTIONS

- » Transparent (Standard)
- » Blue
- » Green
- » Smoked

DIMENSIONS

Max Height 110 cm



SKY LIGHT SYSTEM

GLASS SYSTEMS ▶ FIXED & ADJUSTABLE SYSTEMS

The Sky Light system is a special glass roof that allows you to make full use of the natural light.

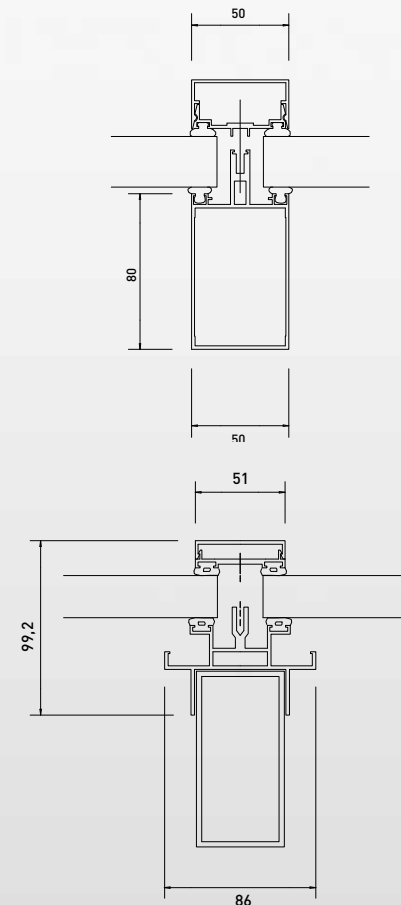
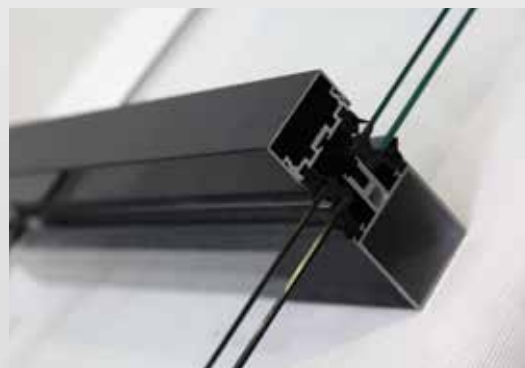

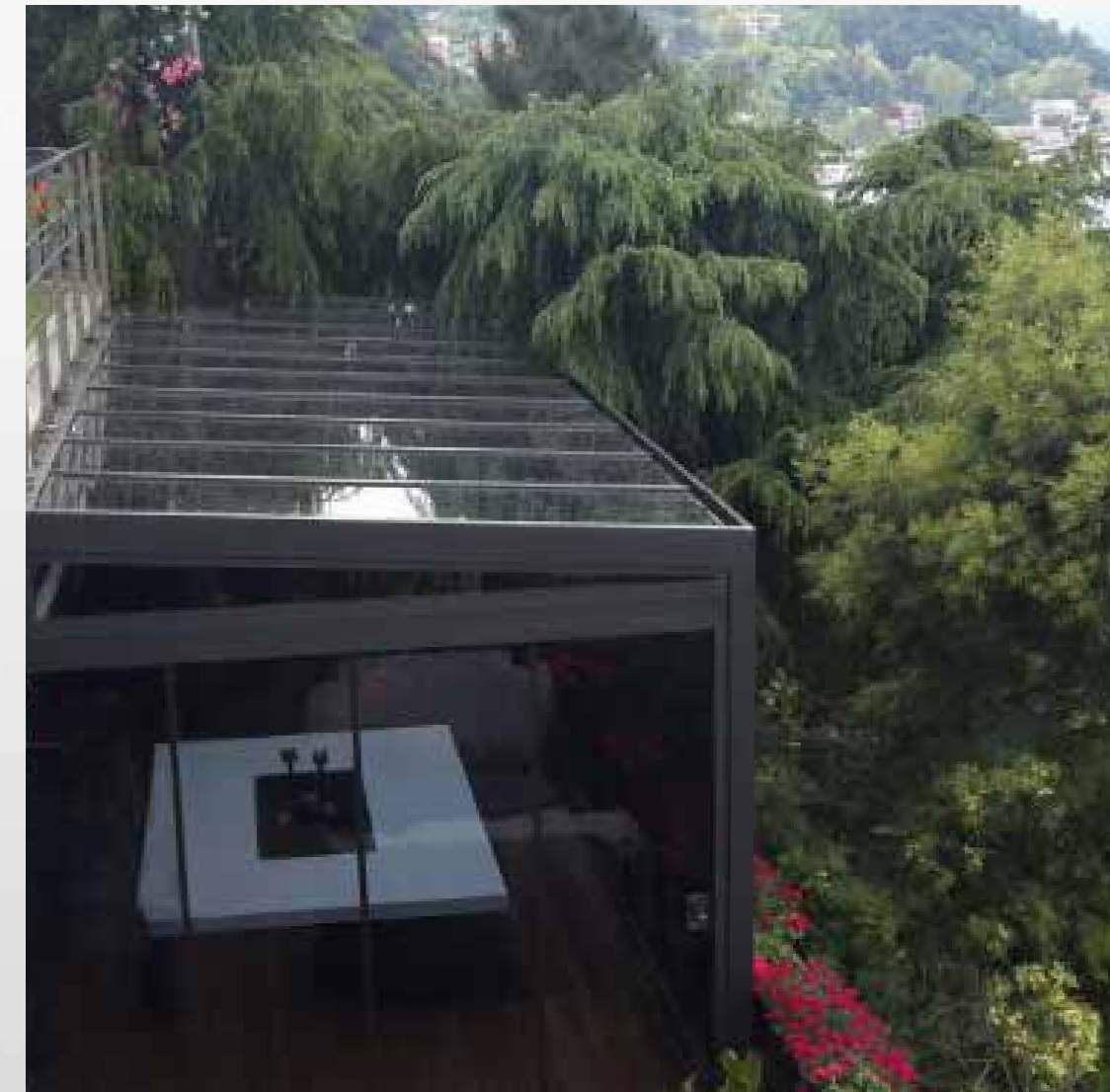



DOOR SYSTEMS

GLASS DOOR

GLASS SYSTEMS ▶ DOOR SYSTEMS

This beautifully designed panoramic glass door is an elegant feature in many buildings.



CONFIGURATIONS



SINGLE DOOR

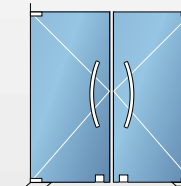

DOUBLE DOOR

GLASS OPTIONS

- » 10mm Tempered
- » 10mm Tempered (Coloured)

GLASS COLOR OPTIONS

- » Transparent (Standard)
- » Blue
- » Green
- » Smoked

DIMENSIONS

Height	200-250 cm	250-300 cm
Wing Width	50-100 cm	50-85 cm

PHOTOCELL DOOR

GLASS SYSTEMS ► DOOR SYSTEMS

This clean cut and stylish door system operates with a photocell sensor.

Security and access control are installed at the top of the frame. At the same time as applying excellent weather sealing qualities the frames are also reduced to the maximum so as to promote visibility.



CONFIGURATIONS

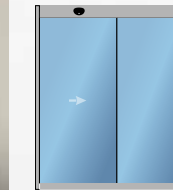

SINGLE-WAY SLIDE

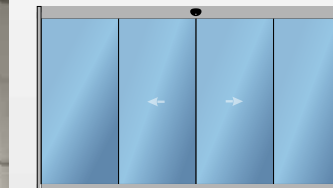

DUAL-WAY SLIDE

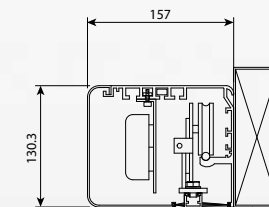

GLASS OPTIONS

- » 4+4mm Laminated Glass
- » 4+4mm Laminated Glass (Coloured)

GLASS COLOR OPTIONS

- » Transparent (Standard)
- » Blue
- » Green
- » Smoked

DIMENSIONS

Height	200-250 cm	250-300 cm
Wing Width	85-100 cm	85 cm
System Width	170-550 cm	170-550 cm

ALUMINIUM DOOR

GLASS SYSTEMS ► DOOR SYSTEMS

This aluminium framed glass door provides a warm, stylish and functional door system.

Its robust, yet smooth operation results in a product you can rely on! The high performance seals protect the building from the elements of nature.

DIMENSIONS

Max Height	300 cm
Width	85-100 cm (One Side)
Glass	4+9+4 (Tempered Insulated)
Glass Color	Transparent (Standard)





ACCESSORIES

HANDLES

ACCESSORIES



CIRCLE

It's beautiful design complements each individual project beautifully.

- » Drill hole in glass: \varnothing 50mm
- » Outer: \varnothing 60mm

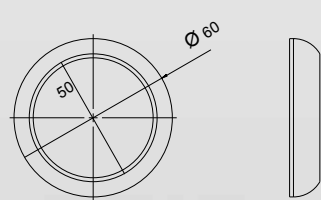

CYLINDER

Both stylish and functional this cylinder door handle is made from stainless steel. Its dual notch design enables it to snuggle perfectly into the hand and it is a preferred option in many projects.

- » Drill hole in glass: \varnothing 10mm
- » Outer: \varnothing 60mm

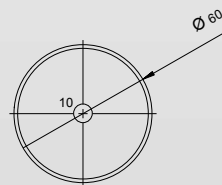

STANDARD DOOR HANDLE

This decorative handle is the indispensable accessory of aluminum doors with its hand holding comfort.

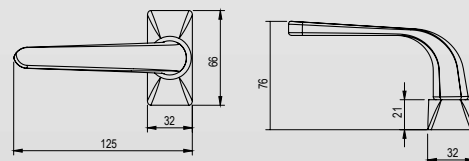

OVAL SERIES

The handle on a door is actually more important than anyone realizes.

- » Drill hole in glass: \varnothing 10mm

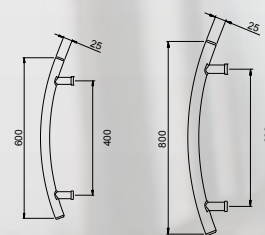

LINEAR SERIES

The stylish Linear Series is a push & pull handle that is screwed directly into the glass door and is available in 4 lengths in stainless steel. With its classic, slim design it fits to any project.

- » Drill hole in glass: \varnothing 10mm

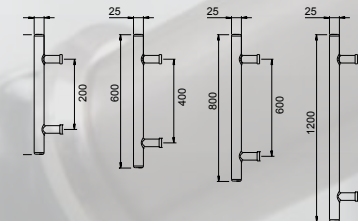

VERTICAL HANDLE

These decorative holders are used throughout the wing height on aluminum doors. Doors are opened and closed by pushing these holders from inside or outside.

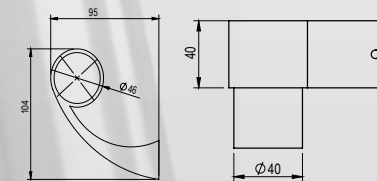

PANIC BAR

Panic bar is used in single and double wing aluminium doors and allows the door to be opened by pushing the bar. The door where this panic bar is fitted can optionally be locked and unlocked from the outside.

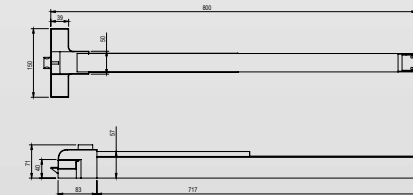

LOCKS

ACCESSORIES



DOUBLE GLASS SLIDING LOCK

This Lock is used on insulated sliding glass panels. With its intelligent Lock-in-feature, all metal parts are made from Stainless Steel and are of highest quality to enable smooth operation which makes it a joy to use.

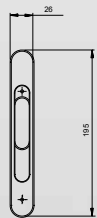

STANDARD FOLDING GLASS KEY LOCK

A reliable locking system with the added benefit of extremely easy installation, our folding glass systems are turned to the locked or unlocked position from the inside and unlocked from the outside with a key.

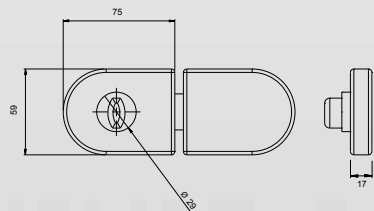

HSM LOCK

In sliding and hanging systems, it enables the first opening wing to be locked with key from inside and outside. These lock connected to the floor.

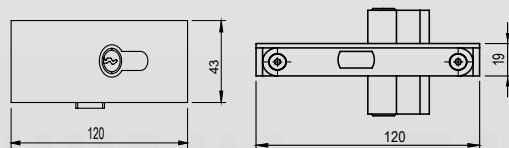

HTP LOCK

It is a stainless steel sliding glass lock, with both lock and handle in a visual concept. Lock is used in 3 and 5 rail sliding glass systems. It should be fitted on a elbow height level. This lock allows the system to be locked from inside and outside.

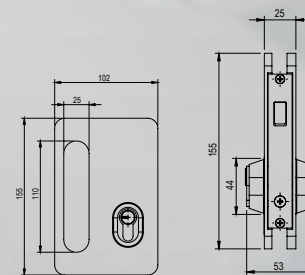

SLIDING GLASS MIDDLE LOCK

This beautiful security system for sliding glass is used on the middle rails of our sliding glass systems. All Metal Parts are made from Stainless Steel.

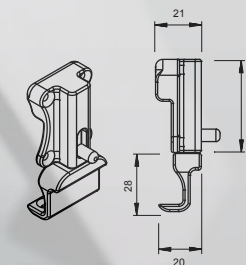

SLIDING GLASS INTERNAL LOCK

This attractive and functional locking system is used in Sliding Glass applications. It is installed on the internal side of the application and all metal parts are made from stainless steel. The bolt is designed to easily slip into the lock.

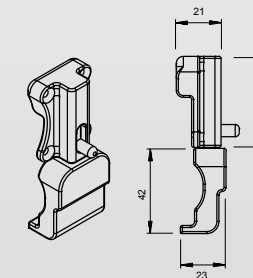





www.palmiye.eu

PALMIYE
Four Seasons Outdoor Living Areas